

PIASTRA ANGOLARE		
CODICE	MATERIALE	QUANTITÀ
91503100	FE	100

FERMASCHIENA

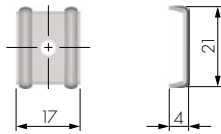

FERMASCHIENA A 4 PUNTE		
CODICE	MATERIALE	QUANTITÀ
63206010	FE	5.000

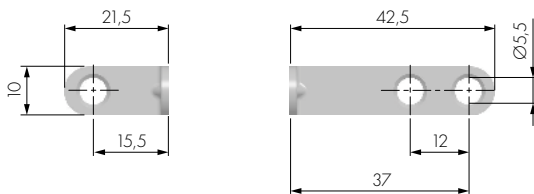

FERMASCHIENA SENZA PIOLINO		
CODICE	MATERIALE	QUANTITÀ
63201010	FE	2.000

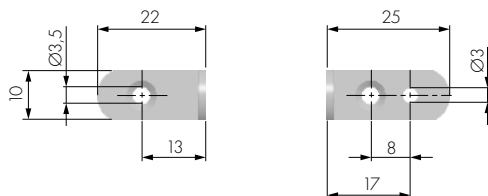

FERMASCHIENA SENZA PIOLINO		
CODICE	MATERIALE	QUANTITÀ
63202010	FE	2.000

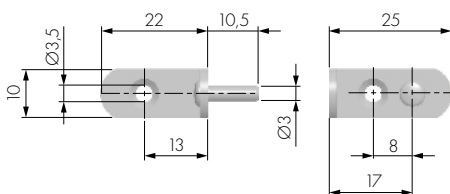

FERMASCHIENA CON PIOLINO		
CODICE	MATERIALE	QUANTITÀ
63202020	FE	2.000



VITE PER SCHIENALE GOLA / LUP

CODICE	L	MATERIALE	QUANTITÀ
63205010	20	FE	10.000
63205020	25	FE	10.000

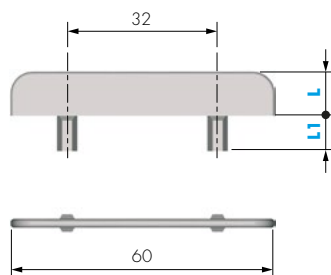

FERMASCHIENA PER FRESATA

CODICE	L	L1	MATERIALE	QUANTITÀ
63203010	10	9	PLAST	7.000
63203030	3	5	PLAST	7.000

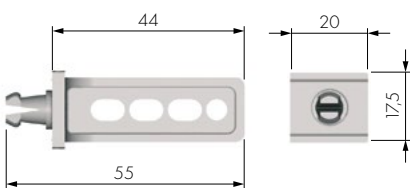

FERMASCHIENA A SCATTO

CODICE	MATERIALE	QUANTITÀ
63204010	PLAST	2.000

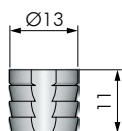

BUSSOLA PER FERMASCHIENA

CODICE	MATERIALE	QUANTITÀ
31506010	PLAST	10.000

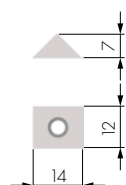

FERMASCHIENA A TRIANGOLO SENZA VITE

CODICE	MATERIALE	QUANTITÀ
63209010	PLAST	10.000

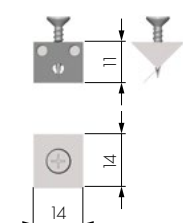

FERMASCHIENA A TRIANGOLO CON VITE

CODICE	MATERIALE	QUANTITÀ
63209020	PLAST - FE	5.000

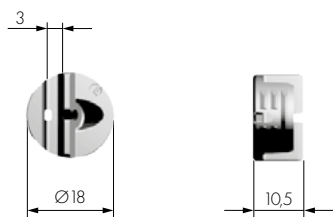

FERMASCHIENA AD INCASSO PER SCHIENA DA 2,5

CODICE	MATERIALE	QUANTITÀ
63208020	PLAST	2.000

FORATURE

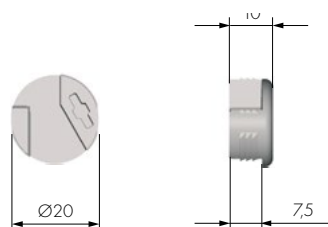
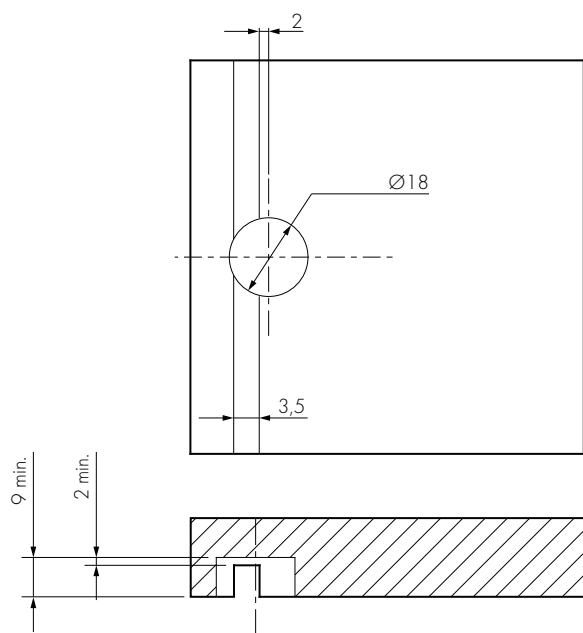

FERMASCHIENA AD INCASSO

CODICE	MATERIALE	QUANTITÀ
63208010	ZAMA	2.000

FORATURE

