

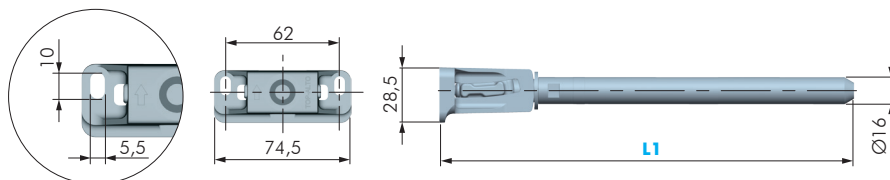

**CARATTERISTICHE:**

- Reggimensola a scomparsa.
- Facilità di montaggio grazie alle tre regolazioni indipendenti, anche a mensola parzialmente montata.
- Versione adatta per mensole in tamburato.
- Spessore mensola minimo 40 mm.
- Brevettato.

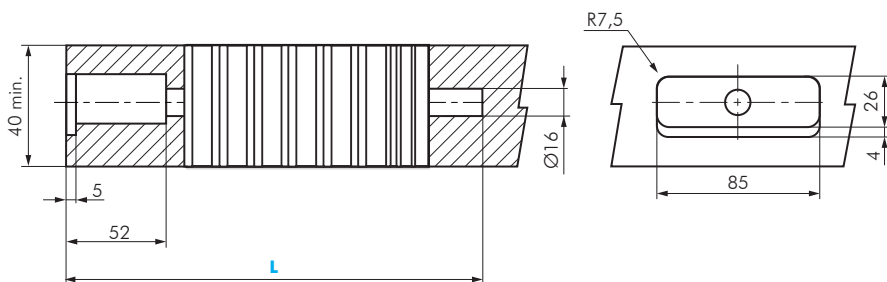

TRIADE MAXI XXL PER TAMBURATO				
CODICE	L	L1	MATERIALE	QUANTITÀ
16217010	290	285	ZAMA - FE	25
16217030	154	149	ZAMA - FE	25

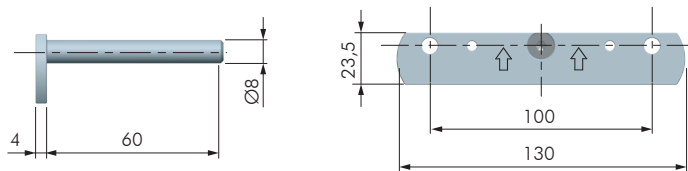
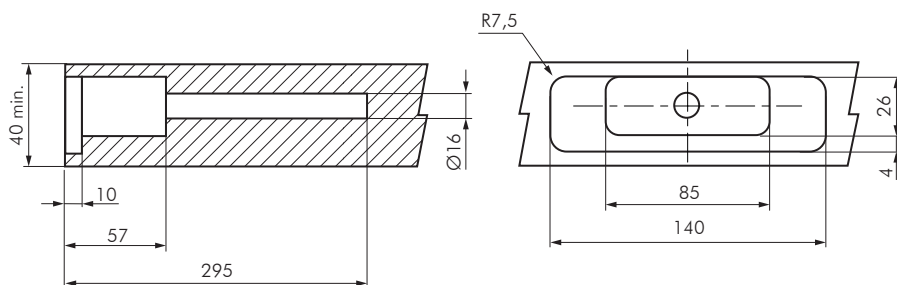

PIASTRA SUPPORTO TRIADE MAXI XXL		
CODICE	MATERIALE	QUANTITÀ
16215030	FE	100



VITE TC M5X12		
CODICE	MATERIALE	QUANTITÀ
60334030	FE	500

UTILIZZARE VITE TC M5X12 PER FISSAGGIO TRIADE A STAFFA.

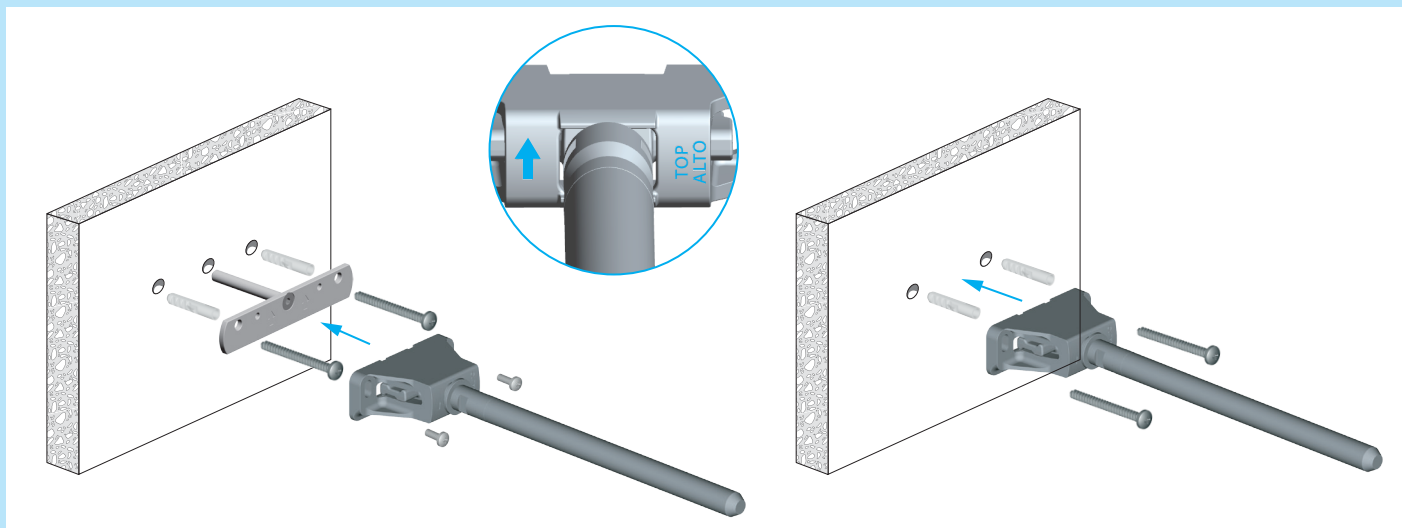

## 1. INSTALLAZIONE CON PIASTRA E SENZA PIASTRA

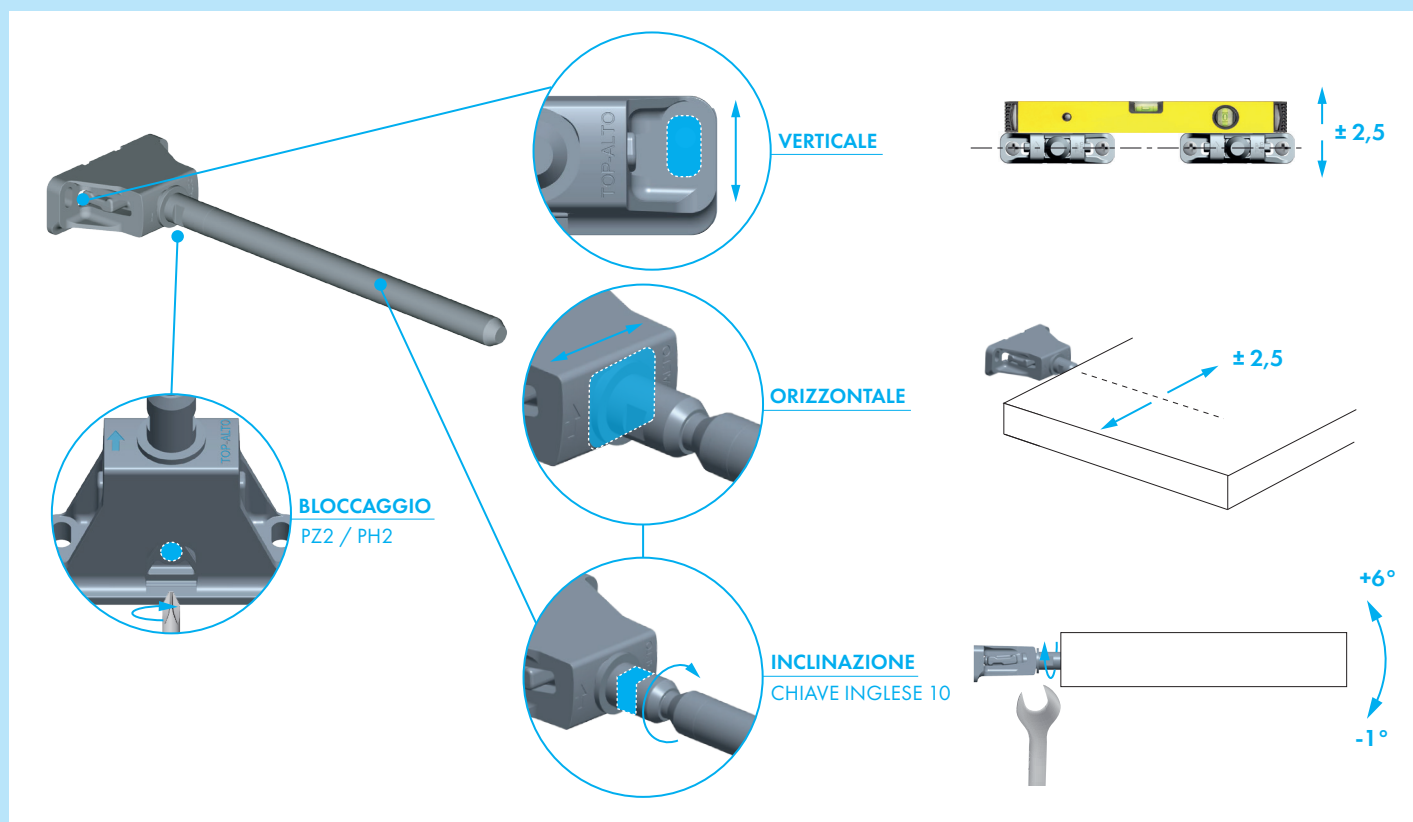

## 2. TRE REGOLAZIONI INDIPENDENTI E BLOCCAGGIO

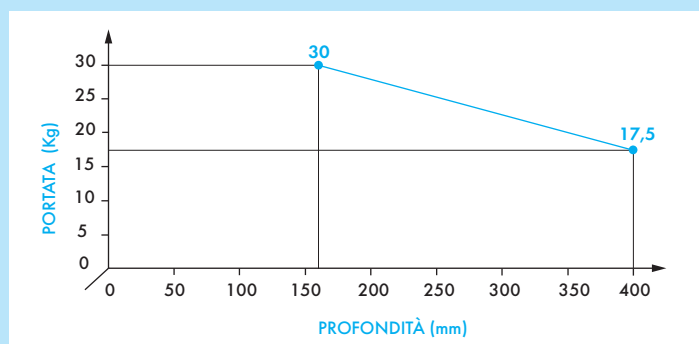

PORTATA RIFERITA A UN REGGIMENSOLA

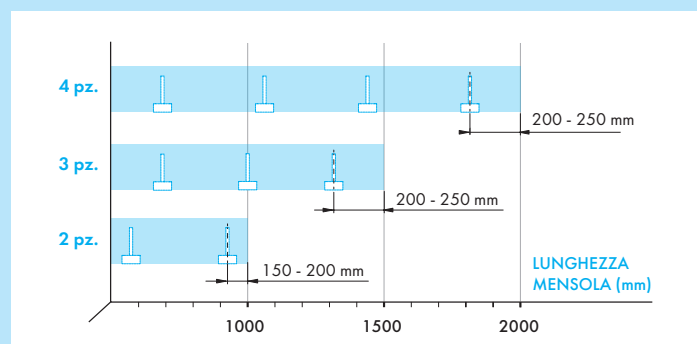

NUMERO DI TRIADE SLIM SUGGERITE PER MENSOLA

SI DECLINA OGNI RESPONSABILITÀ PER EVENTUALI DISFUNZIONI DETERMINATE DALL'INADEGUATEZZA DELLA PARETE DI APOGGIO E/O DEL SISTEMA DI FISSAGGIO.