

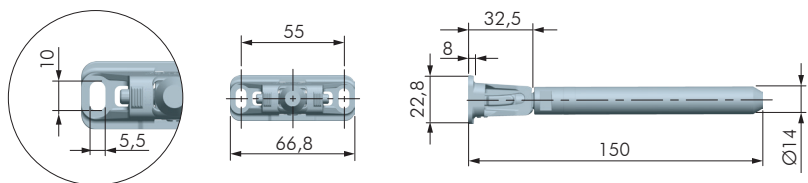

CARATTERISTICHE:

- Reggimensola a scomparsa.
- Facilità di montaggio grazie alle tre regolazioni indipendenti, anche a mensola parzialmente montata.
- Spessore mensola minimo 30 mm.
- Brevettato.

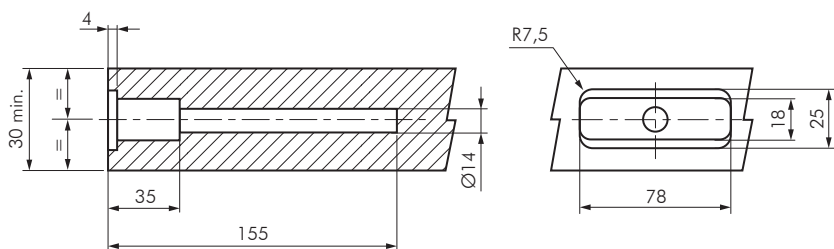

TRIADE

CODICE	MATERIALE	QUANTITÀ
16215010	ZAMA - FE	50

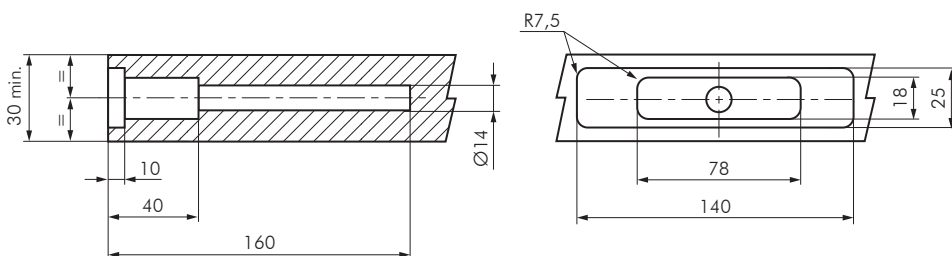

PIASTRA SUPPORTO TRIADE

CODICE	MATERIALE	QUANTITÀ
16215020	FE	100



VITE TC M5X12

CODICE	MATERIALE	QUANTITÀ
60334030	FE	500

UTILIZZARE VITE TC M5X12 PER FISSAGGIO TRIADE A STAFFA.

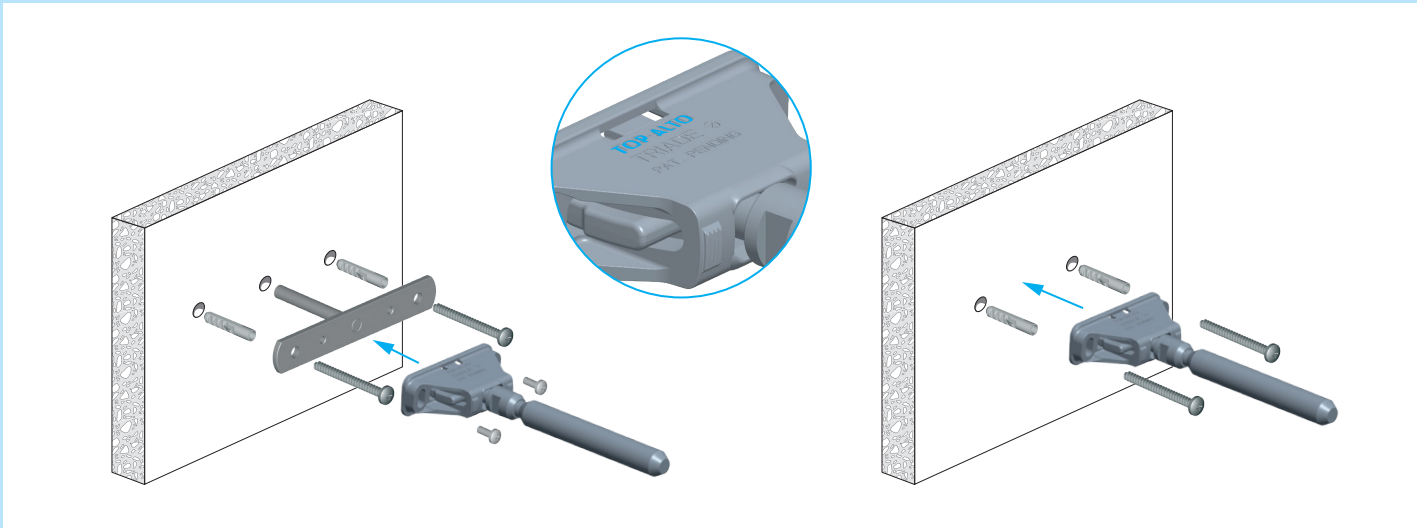

1. INSTALLAZIONE CON PIASTRA E SENZA PIASTRA

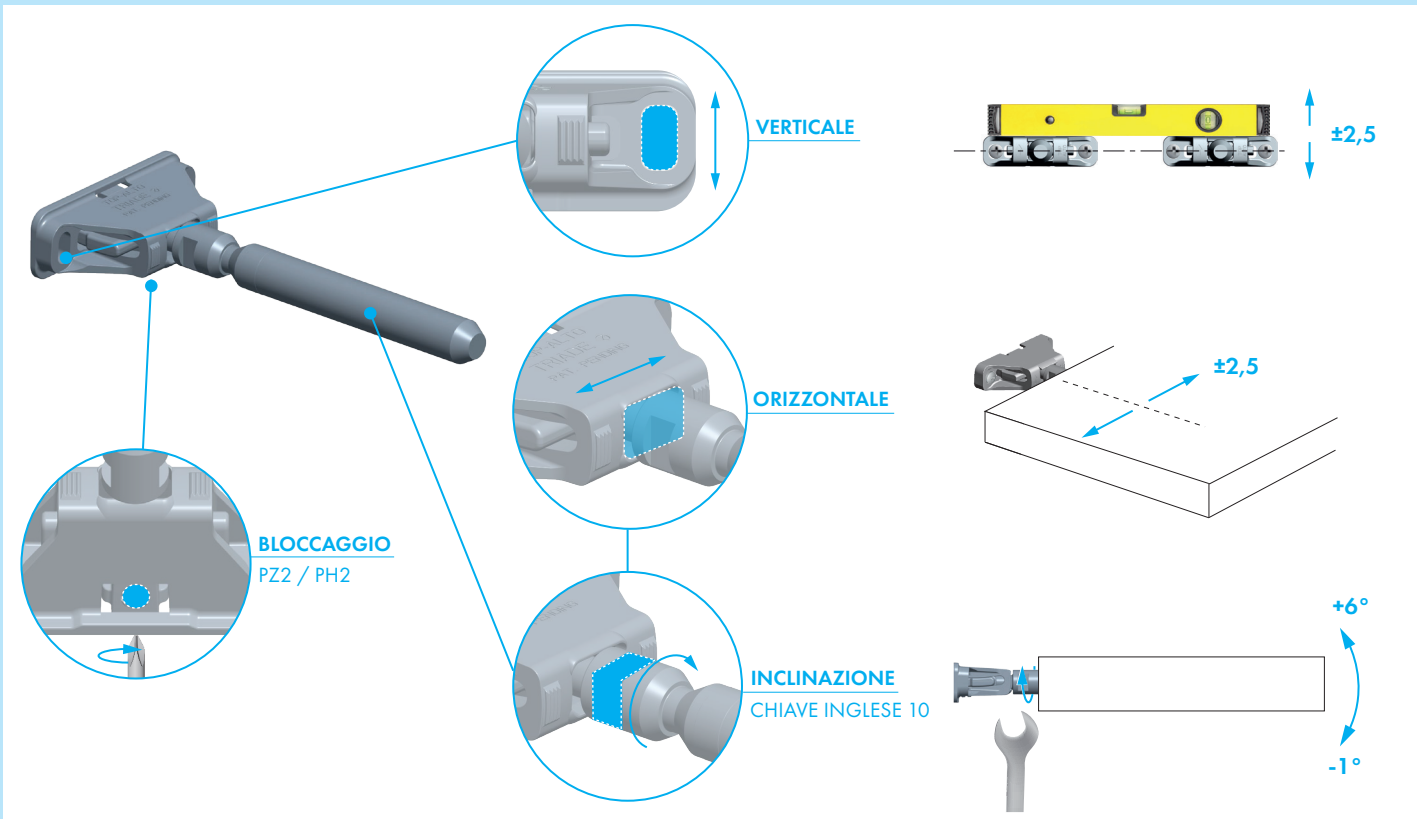

2. TRE REGOLAZIONI INDIPENDENTI E BLOCCAGGIO

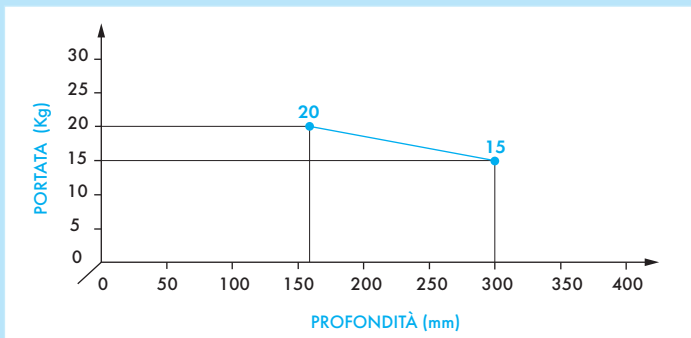

PORTATA RIFERITA A UN REGGIMENSOLA

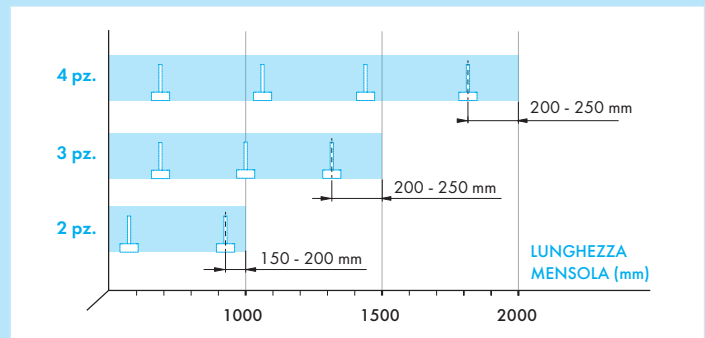

NUMERO DI TRIADE SUGGERITE PER MENSOLA

SI DECLINA OGNI RESPONSABILITÀ PER EVENTUALI DISFUNZIONI DETERMINATE DALL'INADEGUATEZZA DELLA PARETE DI APOGGIO E/O DEL SISTEMA DI FISSAGGIO.