

CODICE	DESCRIZIONE	Ø	Ø1	MATERIALE	QUANTITÀ
80102010	PASSACAVO TONDO	60	72	PLAST	250
80102020		80	92		150

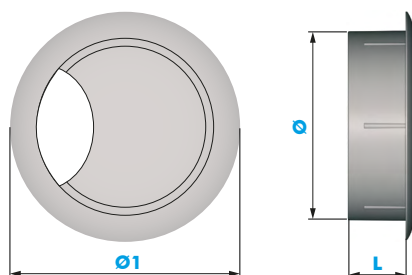

CODICE	DESCRIZIONE	L	Ø	Ø1	MATERIALE	QUANTITÀ
80102110	PASSACAVO TONDO	20	60	70	PLAST	150
80113050		22	80	92		120

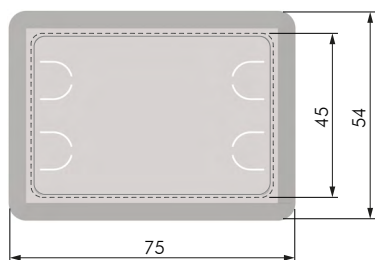
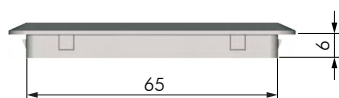

CODICE	DESCRIZIONE	MATERIALE	QUANTITÀ
80107010	PASSACAVO RETTANGOLARE	PLAST	500

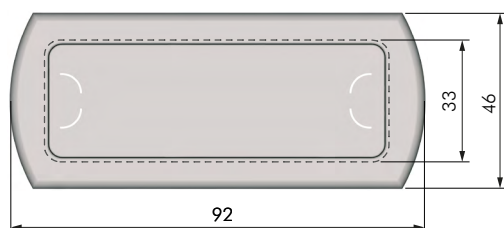
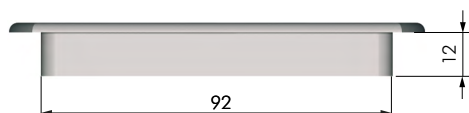

CODICE	DESCRIZIONE	MATERIALE	QUANTITÀ
80108010	PASSACAVO RETTANGOLARE	PLAST	250

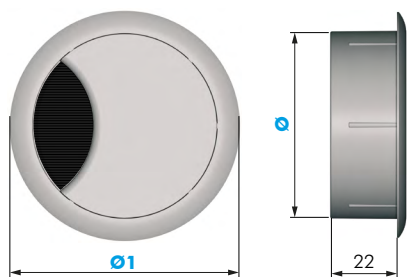

CODICE	DESCRIZIONE	Ø	Ø1	MATERIALE	QUANTITÀ
80102070	PASSACAVO EXECUTIVE ROUND	60	68	ZAMA	50
80102040		80	88		

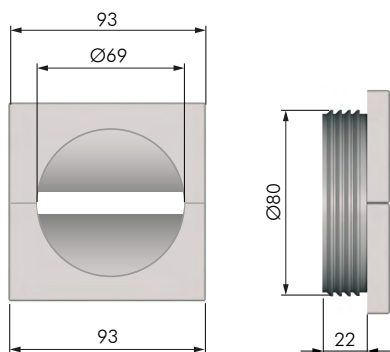

CODICE	DESCRIZIONE	MATERIALE	QUANTITÀ
80114020	PASSACAVO GV	PLAST	160

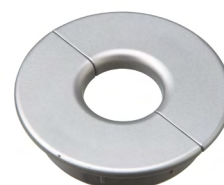
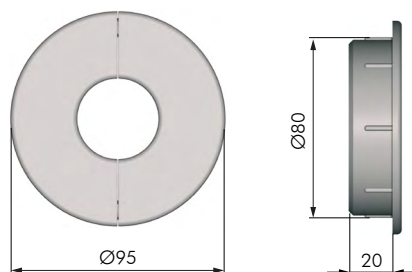

CODICE	DESCRIZIONE	MATERIALE	QUANTITÀ
A RICHIESTA	PASSACAVO TONDO	ZAMA - PLAST	160

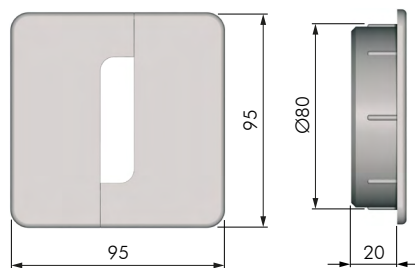

CODICE	DESCRIZIONE	MATERIALE	QUANTITÀ
80114010	PASSACAVO QUADRATO	PLAST	160

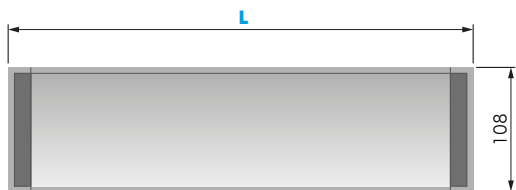

CODICE	DESCRIZIONE	L	MATERIALE	QUANTITÀ
80117060	PASSACAVO TOP ACCESS	300	FE	5
80117010		500		
80117080		750		
80117090		1000		
80117100		1500		

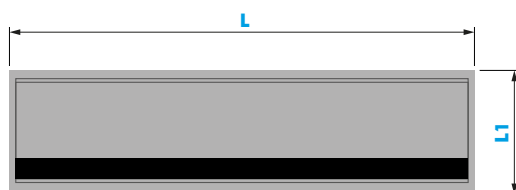

CODICE	DESCRIZIONE	L	L1	MATERIALE	QUANTITÀ
80122010	PASSACAVO EXIT	100	100	FE	5
80122020		240			

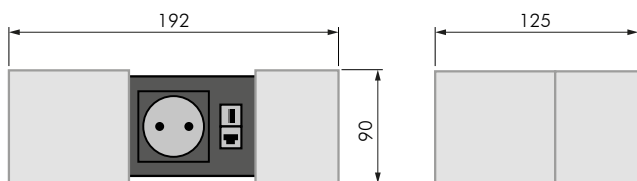

CODICE	DESCRIZIONE	MATERIALE	QUANTITÀ
80508XXX	VERSAPAD	FE	12

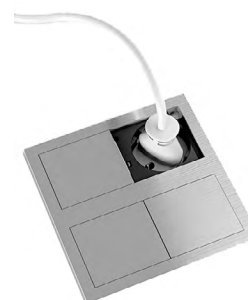
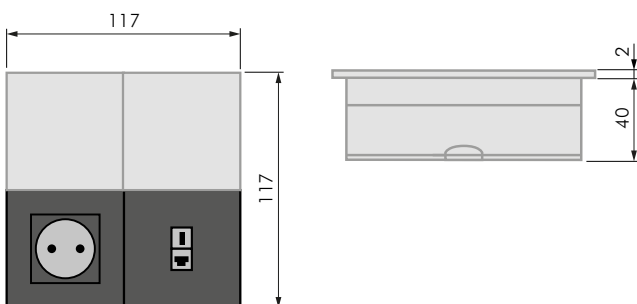

CODICE	DESCRIZIONE	MATERIALE	QUANTITÀ
80509XXX	VERSAHIT DUAL	FE	12

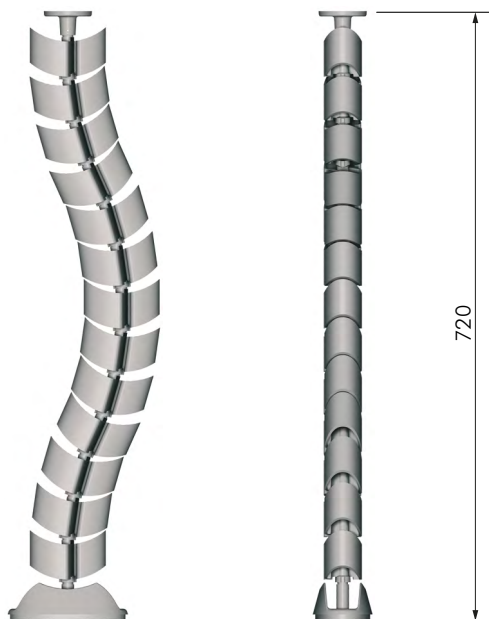

CODICE	DESCRIZIONE	MATERIALE	QUANTITÀ
80601010	VERTEBRA	PLAST	15