

CODICE	DESCRIZIONE	MATERIALE	QUANTITÀ
55006020	CONTROPIASTRA K-PUSH TECH	CON ADESIVO	10.000
55006080		SENZA ADESIVO	20.000

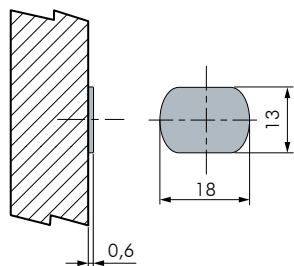

CODICE	DESCRIZIONE	MATERIALE	QUANTITÀ
55006200	CONTROPIASTRA CON ADESIVO K-PUSH TECH	FE	10.000

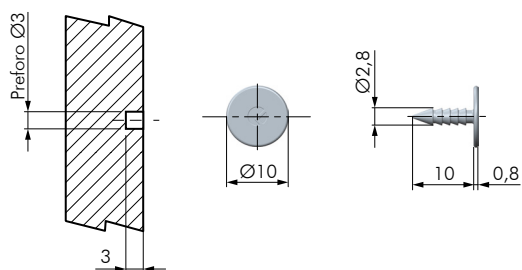

CODICE	DESCRIZIONE	MATERIALE	QUANTITÀ
55006030	INCONTRO PER FORO Ø3 K-PUSH TECH	FE	20.000

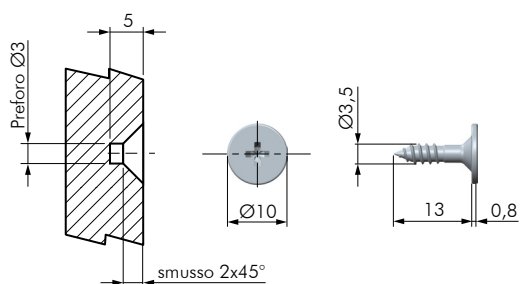

CODICE	DESCRIZIONE	MATERIALE	QUANTITÀ
55006100	INCONTRO MORDENTE LEGNO Ø3,5 L14 K-PUSH TECH	FE	10.000

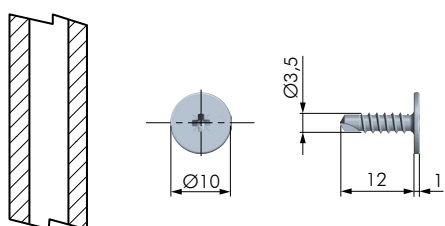

CODICE	DESCRIZIONE	MATERIALE	QUANTITÀ
55006150	INCONTRO AUTOFORANTE Ø3,5 K-PUSH TECH	FE	10.000

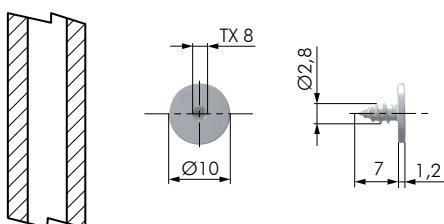

CODICE	DESCRIZIONE	MATERIALE	QUANTITÀ
55006230	INCONTRO AUTOFILETTANTE Ø3,5 IMPRONTA TORX K-PUSH TECH	FE	10.000

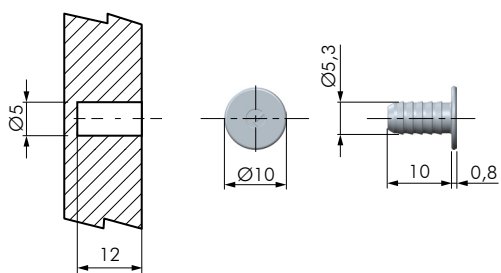

CODICE	DESCRIZIONE	MATERIALE	QUANTITÀ
55006040	INCONTRO PER FORO Ø5 K-PUSH TECH	FE	5.000

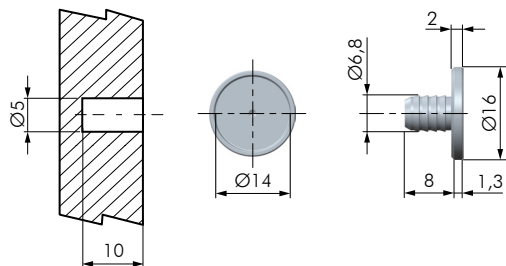

CODICE	DESCRIZIONE	MATERIALE	QUANTITÀ
55006070	INCONTRO PER FORO Ø6 K-PUSH TECH	FE	3.500

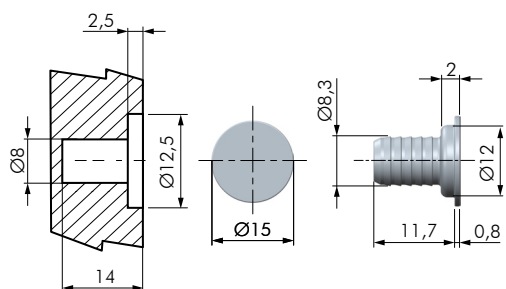

CODICE	DESCRIZIONE	MATERIALE	QUANTITÀ
55006050	INCONTRO PER FORO Ø8 K-PUSH TECH	FE	2.400

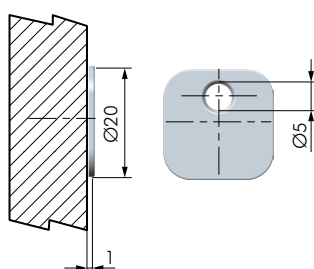

CODICE	DESCRIZIONE	MATERIALE	QUANTITÀ
55006120	INCONTRO QUADRATO CON FORO VITE K-PUSH TECH	FE	5.000

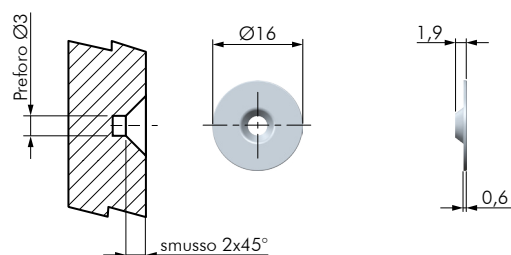

CODICE	DESCRIZIONE	MATERIALE	QUANTITÀ
55006130	INCONTRO ROTONDO CON FORO VITE K-PUSH TECH	FE	15.000

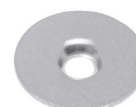

PER CODICE 55006120 E CODICE 55006130 SI CONSIGLIA L'UTILIZZO DI VITE AUTOFILETTANTE TSP Ø2,9 PRESENTE NEL CAPITOLO "VITERIE E SISTEMI DI FISSAGGIO".

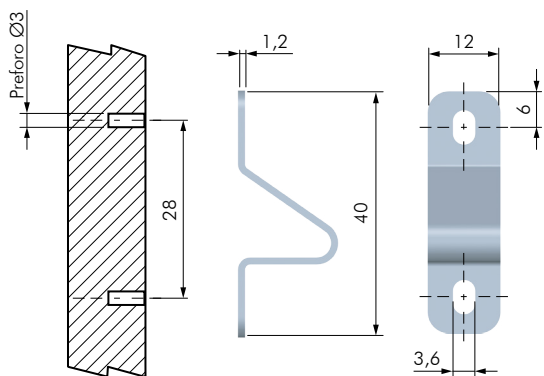

CODICE	DESCRIZIONE	MATERIALE	QUANTITÀ
55006110	BASSETTA PER TERMINALI CURVI K-PUSH TECH	FE	2.500